

DET. 1
ANCHOR TEE ROUND SUPPORT

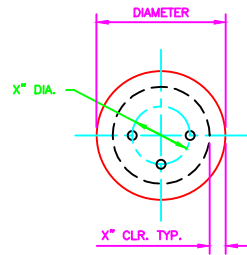

SEC. A
SUPPORT REBAR

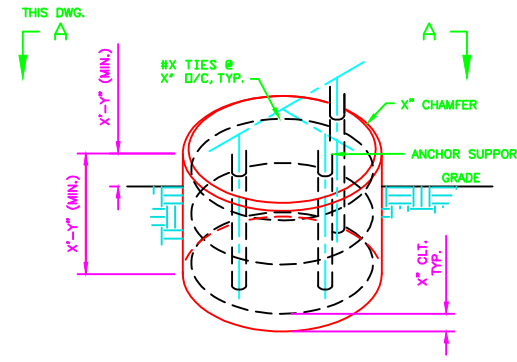

DET. 2
SUPPORT REBAR

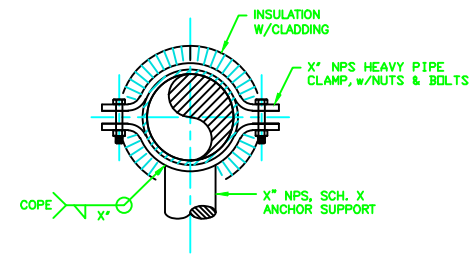

DET. 3
ANCHOR TEE CLAMP

NOTE:
THESE DRAWINGS ARE PROVIDED TO ASSIST IN THE DRAFTING PROCESS FOR VARIOUS STYLES OF PIPE SUPPORTS. THESE DRAWINGS SHOULD NOT BE USED AS A SUBSTITUTE FOR THE DESIGN AND RECOMMENDATIONS FROM A STRUCTURAL ENGINEER.

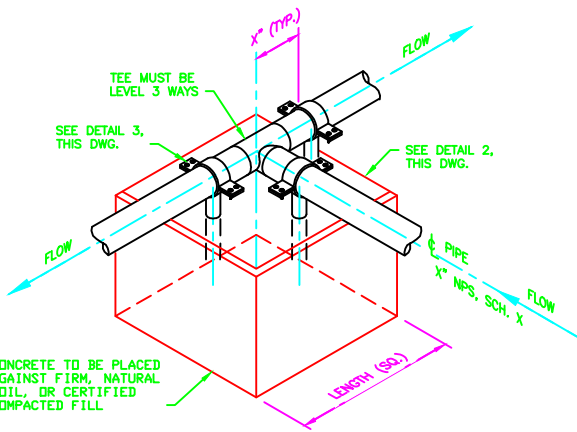

DET. 1
ANCHOR TEE SQUARE SUPPORT

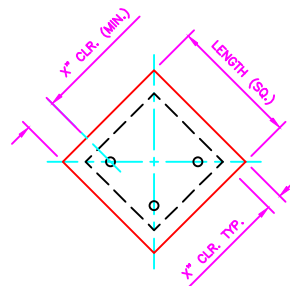

SEC. A
SUPPORT REBAR

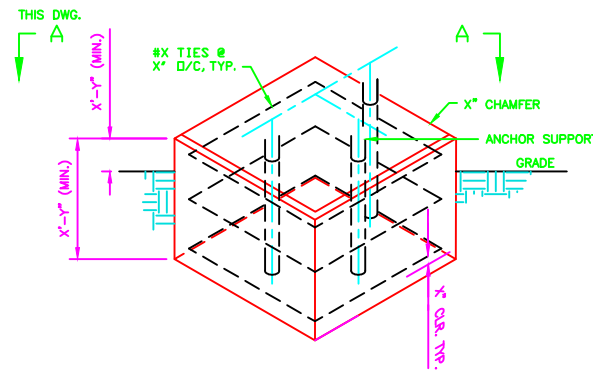

DET. 2
SUPPORT REBAR

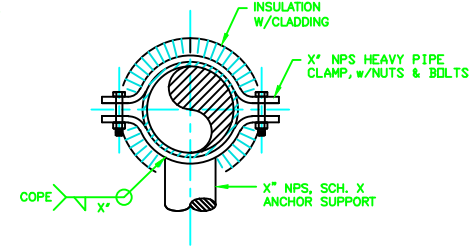

DET. 3
ANCHOR TEE CLAMP